

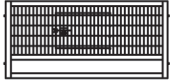









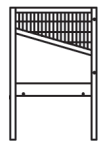

Teile/Parts list

(A) M3.5X50 9pcs	(B) M3.5X30 16pcs	(C) M3.5X25 25pcs	(D) M3.0X16 9pcs	(1)  1pcs
(E) M3.0X12 7pcs	(F)  1pcs	(G)  1pcs	(H)  4pcs	
(2)  1pcs	(3)  1pcs	(4)  1pcs	(5)  1pcs	
(6)  1pcs	(7)  1pcs	(8)  1pcs	(9)  1pcs	
(10)  1pcs	(11)  1pcs	(12)  1pcs		

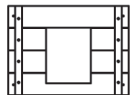
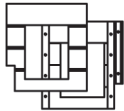

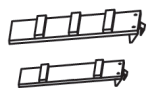
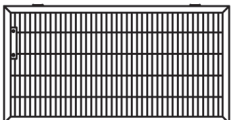
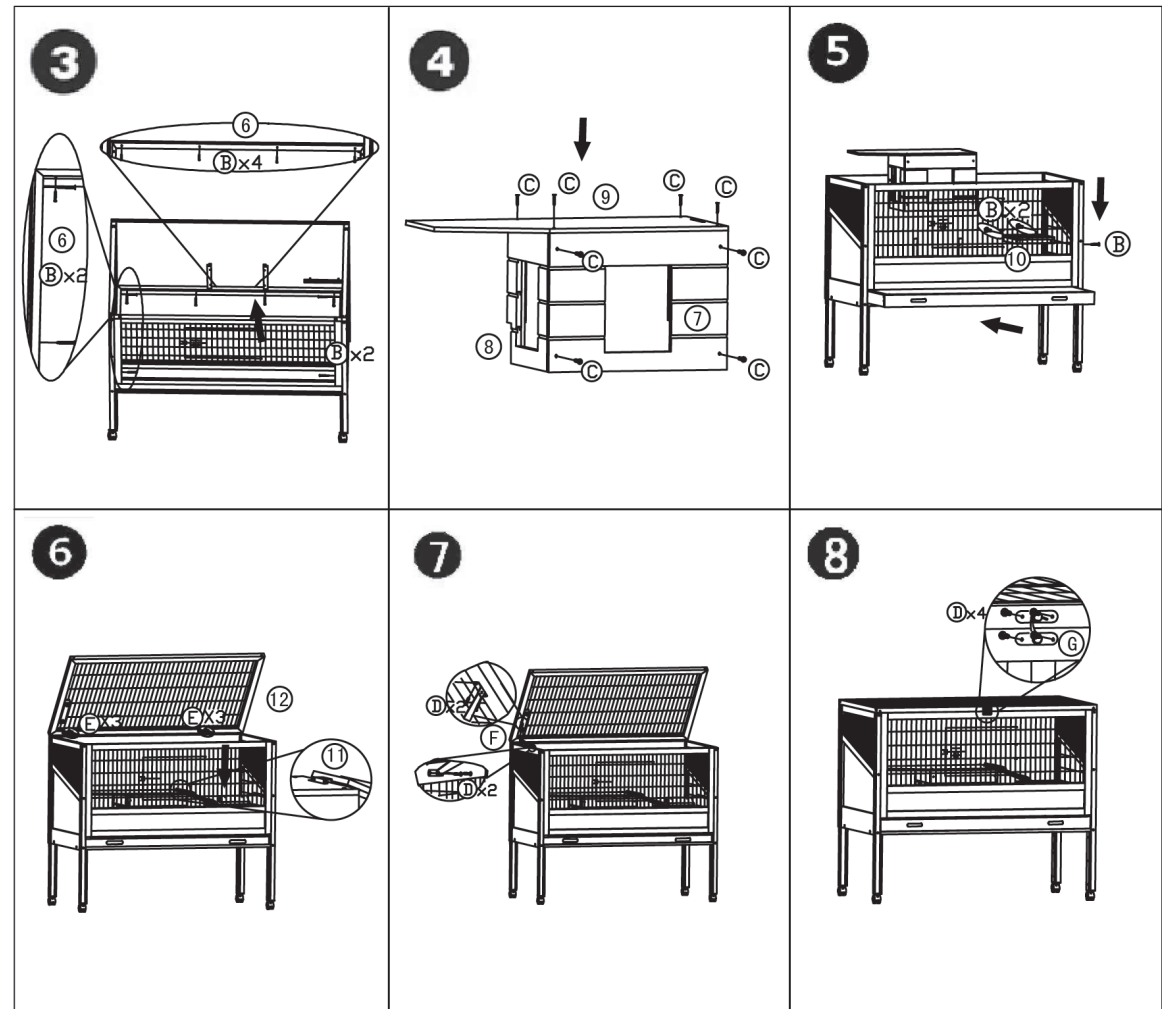
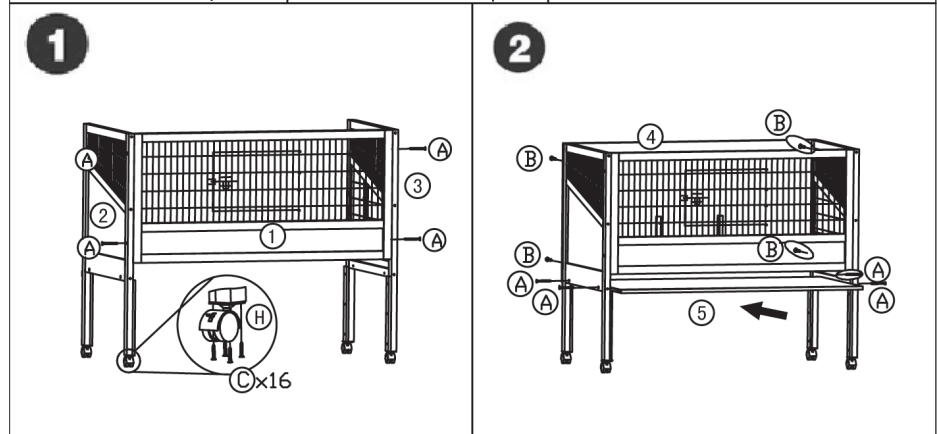
DE

Bitte beachten Sie, dass eventuell durchlaufende Flüssigkeiten wie Wasser oder Urin den Fußboden beschädigen könnten. Der ideale Untergrund sind Stein-, Fliesen- oder Kunststoffböden.

FR

Indication
Veuillez prendre en compte le fait que les fuites de liquides comme l'eau ou l'urine peuvent endommager le fond. Les sols en pierre, carrelage ou plastique constituent les meilleurs fonds.

EN

Note
Please take into account that any liquids that leak out such as water or urine may damage your floors. An ideal base would be stone, tile or synthetic floors.

IT

Nota
Tenere presente che eventuali liquidi come acqua o urina possono danneggiare il pavimento. Il fondo ideale è composto da pietre, piastrelle o plastica.